



CONSTAR

Clinical
Furniture

TASK
MEDICAL

Task Medical clinical furniture has been tried and tested to provide patient comfort and value for money for practitioners Australia wide!

See the full range at

Distributed by:
Constar X Pty Ltd



PO Box 27 Underwood QLD 4119

☎ 1300 778 924 ✉ info@constar.com.au 🌐 constar.com.au

Relieve back stress



- Improved posture
- Improved comfort
- Better ergonomics
- Premium Brand
- Lower Prices

WINBEX

World Class Quality

Authorized Australian Distributor



Mica Saddle Seat

Tilting seat, easy to change height position by using handle

Navy Blue
WX5113201NB

Black
WX113201BL

Premium quality stools at affordable prices

Premium Round Stool



Single lever for height adjustment

Navy Blue
WX002327NB

Black
WX002327BL

Grey Teal
WX002327GT

Comfort Line Stool



140mm / 200mm lift adjustment

Navy Blue
WX002908NB

Black
WX002908BL

Grey Teal
WX002908GT

Ascot Standard Saddle Seat

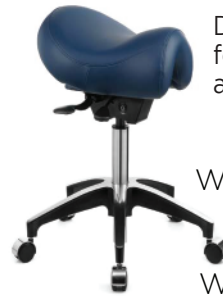

Design and built for ergonomics and comfort

Navy Blue
WX5105S02NB

Black
W51505S02BL

Kimi Saddle Seat



Helps to maintain correct posture

Navy Blue
WX511201NB

Black
WX511201BL

Doctors Stool T Seat



Comfort seat and backrest supports body and spine

Black
WX510710BL

Duma Doctor's Seat



Fully supported body and spine in a sedentary position

Navy Blue
WXDUMANB

Ascot Standard Saddle Seat Back



Backrest provides more support for longer working times

Navy Blue
WX511114NB

Black
WX511114BL

Kimi Saddle Seat With Back



Relieve stress from knees and hips

Navy Blue
WX511202NB

Black
WX511202BL

Microscope Chair

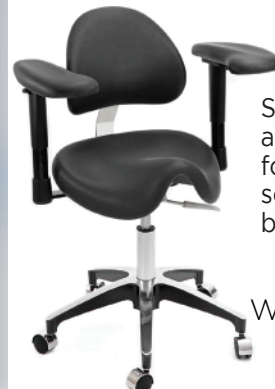

Separate adjustment for seat height, seat tilt and back angle

Black
WX5113301BL

Stainless Steel Trolleys

Task Medical instrument trolleys are manufactured using Hospital Grade 304 Stainless Steel. The trolley is durable whilst providing an aesthetic finish.

**Single No Rails
No Draws**



Order Code
TK0D50NR

Single 1 Drawer



Order Code
TK1D50N

Single 2 Drawer



Order Code
TK2D50N

Single 4 Drawer



Order Code
TK4D50N

**Side rails on
all three sides,
top and bottom**



**95mm
Smooth
running castors**

Long Lasting & Strong

- High grade 304 stainless steel throughout
- Soft closing drawers
- German-made ball-bearing drawer runners
- 125mm deep drawers
- Locks on front castors

Double 2 Drawer



Order Code
TK2D80N

Double 4 Drawer



Order Code
TK4D80N

Powder Coated Trolley

Task Medical Powder Coated 1 & 2 Drawer Trolleys are classified as a high grade trolley with smooth castors and an outstanding finish. It is a perfect alternative to the stainless steel models and comes with a bottom shelf.

Durable & Strong

- Carbon steel powder coated
- Soft closing drawers
- Outstanding finish
- White colour



**95mm
Smooth
running castors**

1 Drawer



Order Code
TK1DPC

2 Drawer



Order Code
TK2DPC

**125mm
deep shelves**

**Side rails on
all three sides,
top and bottom**

Emergency Trolley

Task Medical Emergency Trolley has been specifically designed for the healthcare industry. This updated model is sturdy and with its larger wheels it allows for better mobility, highly responsive and effortless, when moved around.

- ABS moulded table with 304 stainless steel plate
- Four-sided raised stainless steel rim to avoid any falling of equipment
- High-quality aluminium moulded pillar
- Sideboard and backboard (Designed to be detachable)
- All drawers are detachable design and easy to clean
- Smart accessories
- Defib shelf
- Oxygen tank holder
- Central key lock
- Wire basket
- Extension table

Order Code
TKEMTAL5R

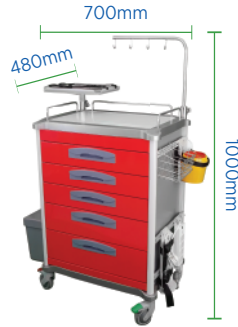

This trolley offers everything you need in an emergency at your fingertips - fast!

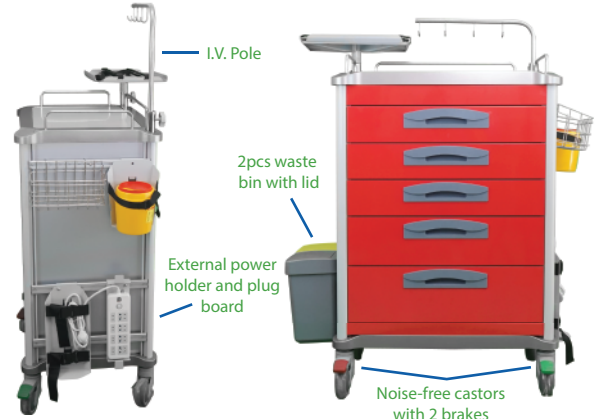

Treatment Trolley

Task Medical Treatment Trolley has a ABS moulded table with 304 stainless steel plate. The trolley has four-sided raised stainless rim's to help avoid any equipment falling.

- Aluminium drawers, side and back panels with aluminium pillars
- Soft closing removable drawers with inner dividers & ABS push handle
- Extended pull out side table
- 304 Stainless steel side basket
- Stainless Steel bench and shelf tops

Noise-free Castors With Front Brakes



Order Code
TK1DTRTWHT



Order Code
TK2DTRTWHT



Available with 1 or 2 Drawers in White colour

Blood Collection Chair

Task Medical Blood Collection Chair is extra wide, comfortable and supportive. The chair includes arm rests and a foldable foot rest.

- Comfortable & supportive with a high density soft foam cushion
- Integrated step stool
- Available in Black & Grey
- Extra wide seat **55cm**
- Width including arm rest: **91.5cm**
- Arm rest width: **18.5cm**
- Length including foot rest: **84cm**



Foldable foot rest

Seated capacity 200kg

Grey
TKBLDCHGY

Black
TKBLDCHBL

IV Infusion Chair

The Task Medical IV Infusion Chair offers comfortability and style. The chair comes with a handy storage basket and it can be adjusted into 3 positions.

Comfortable & Stylish

- Powder coated steel structure
- PU foam seat and back
- Adjusted 3 positions
- Size 84 x 76 x 60 / 112cm
- IV Pole
- Storage basket



Order Code
TKIVCH



Mayo Instrument Trolley

The Task Medical Mayo Trolley is made from stainless steel construction. Some of the key components are its removable tray, adjustable height and lockable castors.

Height Adjustable

- Brush finished 304 stainless steel
- The top tray is detachable
- Four castors with brake
- Tray size 400 x 600mm
- Carrying capacity 35kg
- Dia 75mm castors



Order Code
TKMAYOTR

Overbed Table

The Task Medical Overbed Table is practical and useful, by supporting patients with limited mobility to perform tasks such as eating, drinking, writing and much more.

Gas Strut Adjustable Height

- Top is made of ABS/PP
- Round corner design
- Powder coated iron base with plastic cover
- Silent casters with 2 brakes



Linen Skip

Task Medical single linen skip trolleys are made from hospital grade tubular stainless steel. The linen skip trolley has four easy-glide castors with the front two castors featuring toe-snap brake locks.

Hospital Grade Stainless Steel

- Tubular stainless steel frame
- Front toe-snap castor locks
- Elevated bag support platform
- Size 38 x 54 x 85cm

75mm Smooth running castors



Order Code
TKLIN



Privacy Screen

This mobile Hospital Screen provides privacy for medical staff to examine patients. When not required, the Privacy Screen can be easily folded and stored.

Portable Privacy Screen

- Easy to clean
- Easily stored
- Open dimension: W180 x H185cm
- Panel width: 30cm/per panel
- Wheels for easy movement

Aluminium Molded



Order Code
TKHSP

Step Stool

Task Medical Step Stools are durable and sturdy whilst being useful and efficient when extra height is required.

Heavy Duty

- Chromed steel
- Manufactured with 1" steel tubing
- Size 36 x 28 x 22cm
- 150kg Capacity

SILVER VEIN COLOR

Order Code
TKEST01F



Surgeons Stool

Built to handle a seated weight of up to 130kg, these stools feature a thicker and larger diameter upholstered seat to provide additional comfort.

Heavy Duty

- Lever-operated gas strut-variable height adjustment
- 360-degree swivel castors
- Castor wheels with independent axles
- Net weight 5.5kg

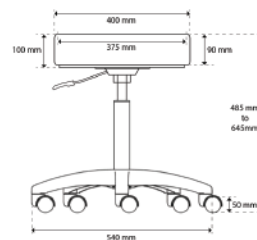



e200 transport stretcher

Equipped with a four-wheel brake system and a central fifth wheel which offers excellent mobility to provide the best safety for patients, the e200 provides durable quality and a 300kg weight capacity.

Order Code

TKST200

- Foot pedal for hydraulic system control on both sides
- Integrated storage tray
- Two-section bed board / Collapsible side rails
- Drainage Bag clasp x 2 / Urinary Bag clasp x 2
- Foot controlled brake / Retractable steering fifth wheel
- Steer pedal for four wheels at both ends
- Head-end delivery push bar / Foot-end assist push bar
- Dual pneumatic assisted backrest
- Two stage movable IV pole x 1
- Two stage permanent folding IV pole x 1
- Velcro tape underneath the mattress
- Protective corner bumpers x 4
- Hook / jack for upright oxygen tank holder
- 300 kg SWL

Multi Purpose Mobility Bed

EZUM HI LO
by TASK MEDICAL

- Recovery room
- Procedure room
- Patient transporter
- Infusion therapy bed
- Emergency stretcher
- 180kg SWL
- Manual wind
- 56-86cm

Order Code

TKEZYM

Ideal for any medical practice!



Easy roller mri safe wheel chair

MR SAFE Certified MR safe (7 Tesla) by Siemens and Phillips

Made from recyclable PE and PA thermoplastics

100% non metallic non magnetic

EasyRoller has been especially designed as a MR SAFE patient transport device for use in hospitals and MR laboratories. Patients can easily be moved through the entire hospital and all the way through the MRI room without interfering with the MRI equipment. Norwegian design, German made.



- No metal parts - Non metallic
- No maintenance recyclable plastic
- Easy maneuvering swivel wheel axle
- Tubeless soft ride tyres & park brake
- Double POM glass ball bearing wheel axles
- Waterproof padded seat, back & armrests
- Approved Standard EN12183 and ISO 7176

Transport patients directly to the mri machine

MRI Safe Wheelchair

Order Code

WHEEASYRL



Camino Medical Hi-Lo Electric Exam Couch

With/without 360° walk-free foot bar control
3 section - Single Motor

This is a Medical Exam Couch with exceptional strength and stability which outperforms many in its class

- Foot pedal control
- Face hole
- Thicker 64mm foam padding
- Gas strut tilt control
- Steel frame
- Front bar key lock
- Lower & raise retractable castors
- Adjustable feet
- Fireproof PU/leather
- 250kg SWL

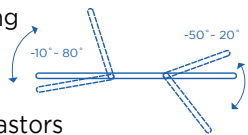

**Available
Black, Charcoal
& Agate Blue**

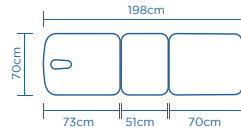

**Walk free
control bar
Agate Blue**



Superior German made motor

WARRANTY
5 YEAR FRAME
3 YEAR ELECTRICAL



250kg SWL

Camino Physio Hi-Lo Electric Treatment Table

Designed to support multiple posture adjustments for physio treatments

- Electric height adjust.
- 46-95cm. SWL 250kg
- A double-sided synchronous pneumatic control of the tail-adjustment mechanism makes it more sturdy, and achieves quiet and fast adjustment

Dual struts



Lower & raise retractable castors



Longer section

Agate Blue

Sonora All Electric Medical Aesthetic Chair

Beauty & Cosmetic
3 section - 3 Motor
Available in Black or White

The Sonora contributes to serve beauty customers with more comfort and indulgence and to improve the treatment capabilities and convenience of beauticians and medical aesthetic clinicians.

- Electric height adjust.
- 56-90cm. SWL 200kg
- Electric backrest 0°-75° angle adjustment
- Electric leg rest 0°-90° angle adjustment
- Body Oil resistant PU leather
- Luxurious 82mm thick high density
- CA-117 fireproof foam padding
- Removable leveled side armrests
- Removable /adjust' neck/face pillow

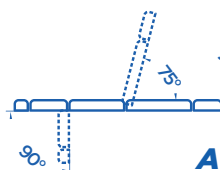
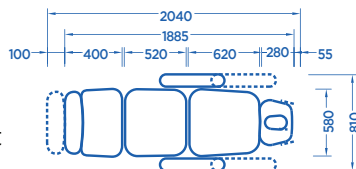

3 Motors
Height motor
Backrest motor
Footrest motor

Face hole

180° swing back arms

Superior German made Motors

More positions

Height & multi-position hand controller

Stylish mono frame lift mechanism

Sturdy base

3 Motor control

Adjustable foot rest extension

**Available
Black & White**



Standard Examination Couch

First Class quality desing & construction affordably priced!

This is a heavy duty examination couch made from heavy grade steel providing an exceptional sturdy base an platform for your patients.

- Australian Desing
- Easy hand lift backrest with 10 stage angle adjustment hinge
- Heavy Duty round tubular legs
- Heavy grade steel constructed frame
- Foam Density: 36g/m2
- Heavy Duty PVC vinyl
- Easy clean and hospital grade
- 260kg SWL

**Available
Black, Grey & Navy Blue**



Standard Fixed Height Examination Couch

- Fixed height 82cm
- Two section
- Adjustable angle, lift up back rest
- Powder coated steel frame
- New easy lift and lock mechanism for easy 2 minute assembly
- Comes flat packed, easy to assemble
- Padding thickness 5cm, Foam Density: 36g/m2
- Total Length: 195cm
- Width: 71cm
- Height: 82cm
- 250kg SWL

250kg SWL

**Available
Grey & Navy Blue**



MRI Safe Stretcher

With adjustable height and drip stand

The Task Medical MRI Conditional stretcher is Non Magnetic and compatible / suitable for 1.5T and 3.0T MR conditional equipment.

- Aluminium construction
- Adjustable (hand crack) height*
- Adjustable back rest
- Safe Working Load 169kg
- 70mm thick padded mattress
- Drop down side rails
- Stainless steel IV pole
- 125mm castors, 2 with brakes
- Back rest adjustment range 0-75 degrees (lever)
- Max Height 189cm
- Min Height 46cm
- Overall Length 189cm
- Overall Width 56cm



Multipurpose Treatment Chair

Hi-Lo 3 Section / 2 Motor / Grey Upholstery

Task Medical's podiatry chair focuses on patient comfort, with armrests and a long backrest reaching head height. The position variations provide better positions for the practitioner's examination or treatment procedures.

- Double gas strut back adjustment and single gas strut foot adjustment,
- seat and height of table adjustable by actuators
- Four retractable medical grade castors
- Four large pad levelling feet
- 1 pair adjustable tilt back armrest
- Medical grade PVC vinyl
- Size 190mm L x 600mm W
- Adjustable height range 510-950mm
- Adjustable backrest 0 degrees to +78 degrees
- Adjustable footrest 0 degrees to -90 degrees
- 250kg SWL

**250kg
SWL**



Deluxe Gynaecology Chair With Stirrup & Foot Boards

3 Section / 2 Motor / Deluxe Gynaecology Chair - Table / Blue

- Double gas strut back adjustment
- Four retractable medical grade castors
- 2 large rear pad levelling feet
- 1 pair adjustable arm rests
- 1 pair stirrup leg supports
- 1 pair foot boards
- 1 stainless steel debris tray
- Medical grade PVC vinyl upholstery
- Size 1820 x 600mm
- Adjustable back: 0 to 80 degrees
- Adjustable seat: 0 to +20 degrees
- Adjustable height: 590-1060mm
- 2 piece actuator with foot switch adjustable height and seat
- 250kg SWL

**250kg
SWL**



Stainless Steel Mobile IV Stand With 4 Hooks & Chrome Base

Mobile IV Stand with 4 hooks

- Mobile support pole for intravenous use
- Adjustable height
- Double hooks for dual capacity
- Five star metal base for maximum stability
- Swivel castors
- Durable chromed steel pole



TASK
MEDICAL



We've got you covered!

***Over 300 medical products from our proven brands
to help you improve your patient care!***

- ☆ ***Single Use & Reusable Holloware***
- ☆ ***Recyclable, Biodegradable & Compostable***
- ☆ ***Ultrasound Consumables***
- ☆ ***Apparel & Protective***
- ☆ ***Consumables & General Medical***
- ☆ ***Paper Rolls & Sheets***
- ☆ ***Clinical Furniture***

See the full range at

www.constar.com.au